

KRAIBURG KEW Plus LongLine / KEW Plus LongLine TarsaCare

Prerequisites:



concrete surface:

- no holes
- no elevations
- min. 3 % slope

mats:

even temperature:
min. 5° C to max. 30° C
(store according to initial
temperature)

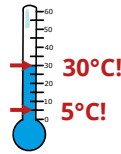

For animal well-being some
bedding is necessary to
absorb moisture (e.g. soft
milled straw or mineral
material)

You will need this:

measuring:

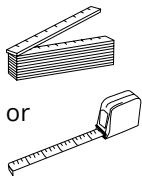

marking:

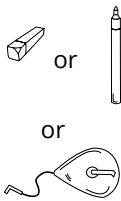

cutting:

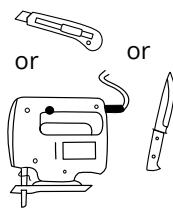

drilling and installing:

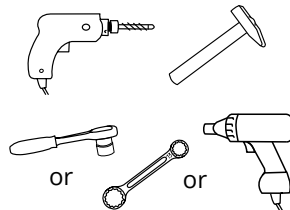

KRAIBURG fixing elements:

- framing plugs \varnothing 10 x 100 mm with
• hexagon screw (SW 13) - A2
• washer \varnothing 30 mm - A2

- framing plugs \varnothing 10 x 135 mm with
• hexagon screw (SW 13) - A2
• washer \varnothing 30 mm - A2

(fixing elements are part of delivery)

1 Placement line

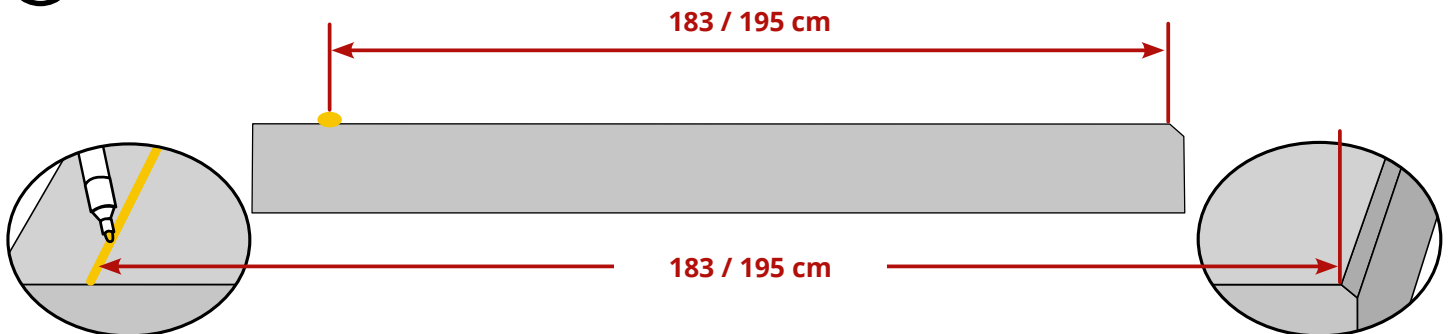

draw placement line at the front
Tip: use a chalk line

measure from the
rear concrete edge

2 Lay out lower mats and foam

Position lower mats along the placement line, allow space for the closure bars on the side edges
(see step 5)

KRAIBURG logo on head edge

positioning bars

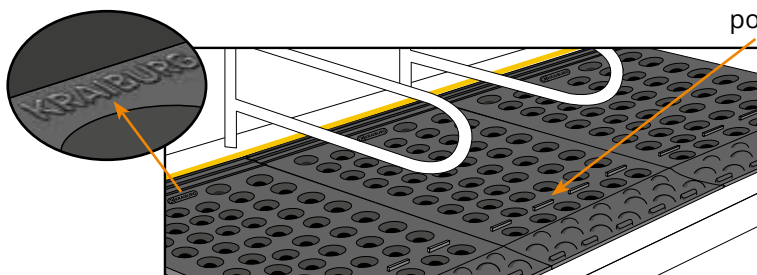

lay out lower mats

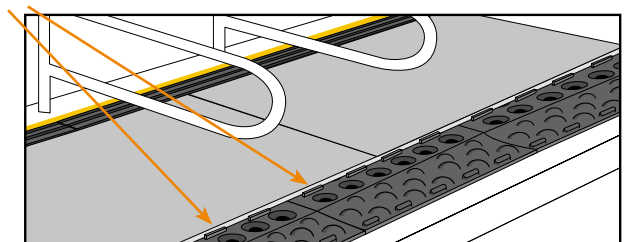

insert foam crosswise within the positioning bars



3 Roll out and position rubber cover

head edge:
the connecting
grooves of the
upper mat and
the lower mat
engage perfectly

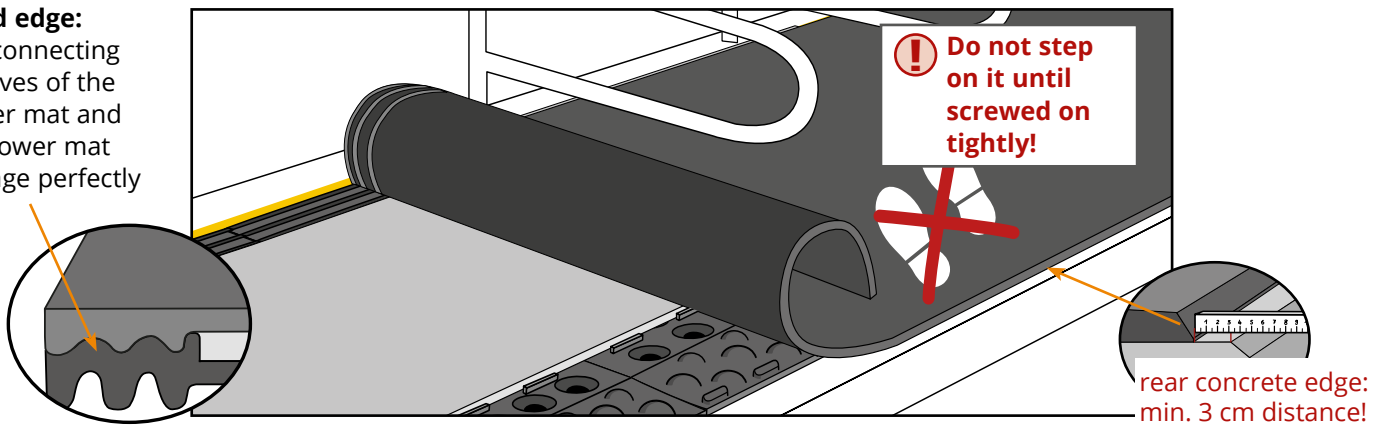

! Cutting out pockets for pillars etc. is not possible!

4 Fix

i Start from the middle of the roll and fix to the right and to the left

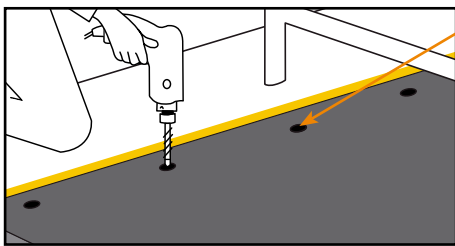

fix at the front edge through the prefabricated fixing points

! Make sure the front edge of the mat is on the marking. Readjust, if necessary.

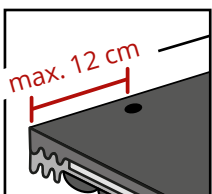
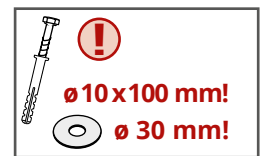

distance between mat edge and last fixing points: max. 12 cm!

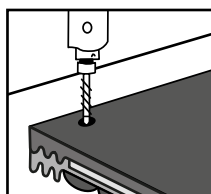

if distance exceeds 12 cm:
place an additional fixing point

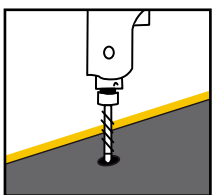

drill

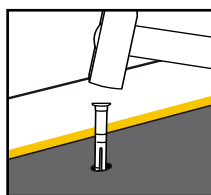

pound the plastic plugs in flush

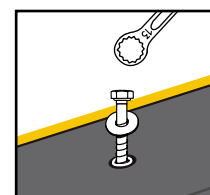

fix screws and washers

! Fix screws until they are seated evenly fast and are slightly countersunk. **Do not overtighten!**

5 Fix side mat edge with closure bar

A Position bars

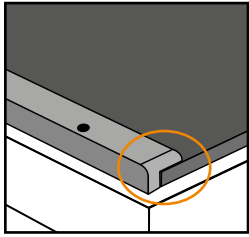

left edge with bar

KEW Plus LL-L

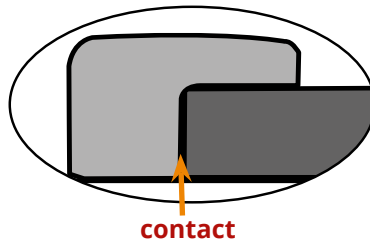

contact

! DO NOT PRESS!

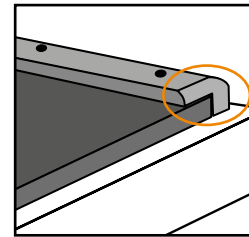

right edge with bar

KEW Plus LL-R

- rounded off end on the rear edge
- flush with rear mat edge

B Fix bars

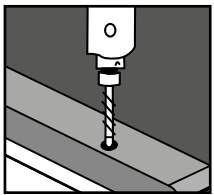

drill

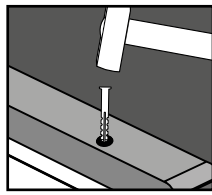

pound the plastic plugs in flush

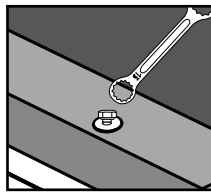
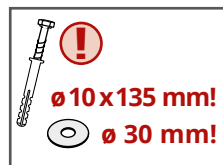
fix screws and washers until they are seated evenly fast; **do not overtighten!**

ø 10 x 135 mm!
ø 30 mm!



Tip: avoid slippage:

- fix at one fixing point
- afterwards drill further holes and so on

6 Optional: connect two rolls with a middle profile (under a divider)

A Insert middle profile **KEW Plus LL-M**

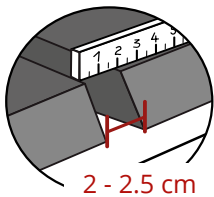

2 - 2.5 cm

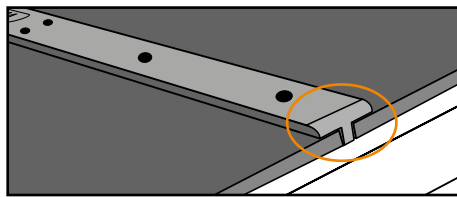

- rounded off end on the rear edge
- flush with rear mat edge

! DO NOT PRESS!

B Fasten profiles: see 5 B